



Cornell Pumps for your Agricultural, Industrial and Municipal application needs since 1946.



Clear Liquid Pumps:

Applications: Agricultural Irrigation, Golf Course Irrigation, Aqua Culture, Fountains, Breweries, Laundries, Cooling Towers, Fire Fighting, Reverse Osmosis Feed, Water Booster.

Models: W, Y, R and H series.

Sizes: Discharge sizes from 1 to 10 inches. Heads to 450 ft. TDH, flow rates to 7,000 GPM.



Solids Handling Pumps:

Applications: Municipal Waste Water, Lift Station, R.A.S./W.A.S., Industrial Waste Water, De-watering, Construction, Dredging, Reclamation Plants, Foundry or Mill Slag.

Models: Delta™, Semi-Open Impeller, Enclosed Impeller, Grey Water Impeller and Chopper Impeller.

Sizes: Discharge sizes from 3 to 30 inches. Heads to 450 ft., flow rates to 40,000 GPM.



Submersible Pumps:

Applications: Sewage Lift Stations, Sewage Processing, Storm Water Reclamation.

Models: Delta™, Semi-Open and Enclosed Non-clog Impeller.

Sizes: Discharge sizes from 4 to 20 inches. Heads to 350 ft., flow rates to 20,000 GPM.



Manure Slurry Pumps:

Applications: Liquid Manure Transfer, Injection Systems, Big Gun Applications.

Models: Delta™, Semi-open Impeller, Enclosed Impeller, Grey Water Impeller and Chopper Impeller.

Sizes: Discharge sizes from 1.25 to 8 inches. Heads to 450 ft., flow rates to 5,000 GPM.



Food Hydro-Transport Pumps:

Applications: Hydro-Transport of Food Products: potatoes, carrots, peaches, corn, beets, live fish and more.

Models: P and PP series and FF.

Sizes: Discharge sizes from 3 to 12 inches. Flow rates to 8,000 GPM.



Hot Oil Pumps:

Applications: Hot Oil Circulation for french fries, potato chips and other fried foods, Heated Transfer Fluid, Hydraulic Oils, Petroleum Transfer.

Models: W, Y, R and H series.

Sizes: Discharge sizes from 1 to 10 inches. Heads to 420 ft., flow rates to 5,500 GPM.



Refrigeration Pumps:

Applications: Ammonia, Fluorocarbon and Glycol Refrigeration Systems.

Models: CB Series (mechanically sealed), HT Series (canned motor) and clear liquid pumps for Glycol.

Sizes: Discharge sizes from 1.25 to 4 inches.



Chopper Pumps:

Applications: Food Processing, Wood Products, Mining, Sludge Transfer, Digester Scum Blankets, Animal Slurries.

Models: 4NC and 6NC.

Sizes: Discharge sizes from 4 to 6 inches. Heads to 275 ft., flow rates to 1,500 GPM.



D.A.F. Pumps:

Applications: Dissolved Air Floatation, Aeration, Refineries, Textiles, Water Treatment, Industrial and Municipal Wastewater Treatment.

Models: 1.25DA1 through 4DA2.

Sizes: Discharge sizes from 1.25 to 4 inches. Flow rates to 600 GPM.



Hydro-Turbines:

Applications: Hydro-Electrical Generation.

Models: 1.25TR1-10TR2.

Sizes: Inlet sizes from 1.25 to 10 inches, exhaust sizes from 2 to 12 inches. Flow rates to 18 CFS. Efficiency up to 89%.



The Cornell Advantage

Various Mounting Configurations:

Close-coupled (CC), Vertical Close-coupled (VM), Horizontal Frame Mounted (F), Vertical Coupled (VC), Vertical Frame Mounted (VF), Horizontal Engine Mounted (EM). Modular Frame design allows for easy part substitution and application adaptability.

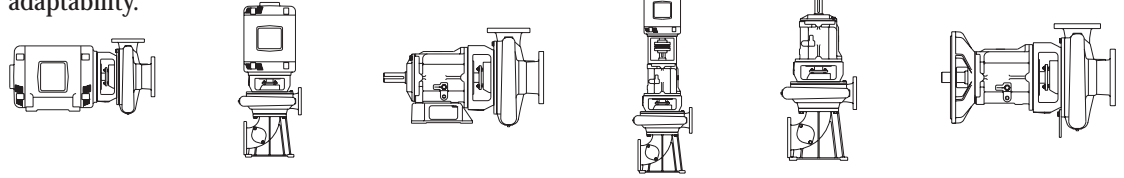

Various Material Options:

Cast iron, Ductile Iron, Heat-Treated Ductile Iron, Bronze, Navy Bronze, various Stainless Steel grades including Duplex and Super Duplex Stainless Steel, and other materials are available to meet your application needs.

Cycloseal® Option:

No seal flush, no vent line and no lubrication is required for this seal. Cornell's Cycloseal® lasts many times longer than a typical mechanical seal. This saves on the installed cost of a seal water system and its on-going maintenance; not to mention the savings of thousands of gallons of seal water over the life of the pump.

Run-Dry™ Option:

A great feature for protecting your mechanical seal. Allows your pump to run dry without the use of expensive water systems and without mechanical seal damage.

Double Volute Design:

Reduces radial thrust, for longer seal life, bearing life and shaft life.

Balance Line:

Used for Clear Liquid pumps, the external balance line reduces axial thrust and flushes debris from the seal area prolonging bearing, shaft and seal life.

Immersible Motor Design:

The latest technology in Dry-Pit pump applications. The Immersible motor provides the right solution for flood-plane installations. Cornell immersible motors have efficiencies of up to 96%. Coupled with Cornell's well known high efficiency pumps, they provide the best possible combined efficiencies for an outstanding operations savings. In addition, Immersible Motor maintenance is negligible compared with Dry-Pit submersible motors.

Immersible Bearing Frames:

Allows your bearing frames to be submerged without causing damage to the pump bearings. Can be serviced by any authorized pump house. Exceptional shaft and bearing life. Available for 4"-30" pumps.

Redi-Prime® Pumps:

A great product for any application that requires a self-priming pump. Our Redi-Prime® pumps can do the job with efficiencies as much as 20%-30% higher than typical self priming pumps. In addition, our Redi-Prime® system is available on clear liquids and solids handling pumps with up to 30 inch discharge sizes and heads as high as 300 feet.

Redi-Prime® System:

The Redi-Prime® system includes a vacuum assisted diaphragm pump, Cycloseal® and Run-Dry™ features. It is a compact, fully automatic, self-priming system, and delivers high Hydraulic Efficiencies.

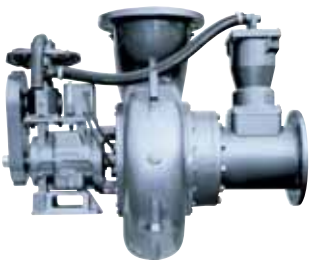
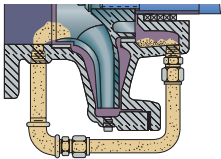
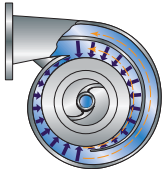
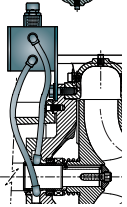
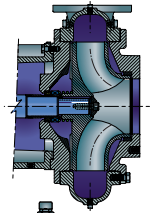

Clear Liquid Pumps

Feet x .305 = Meters
 Inches x 25.4 = Millimeters
 GPM x .227 = Cubic Meters/Hour
 GPM x 3.785 = Liters/Minute
 HP x .746 = KW

Speed	Impeller Dia.	Style	Solids Dia.	N _S	Suction	Discharge	No. vanes
VARIOUS	12.75	ENCLOSED	.84"	1332	6"	4"	7

SINGLE VOLUTE

MOUNTING CONFIG.: F, EM

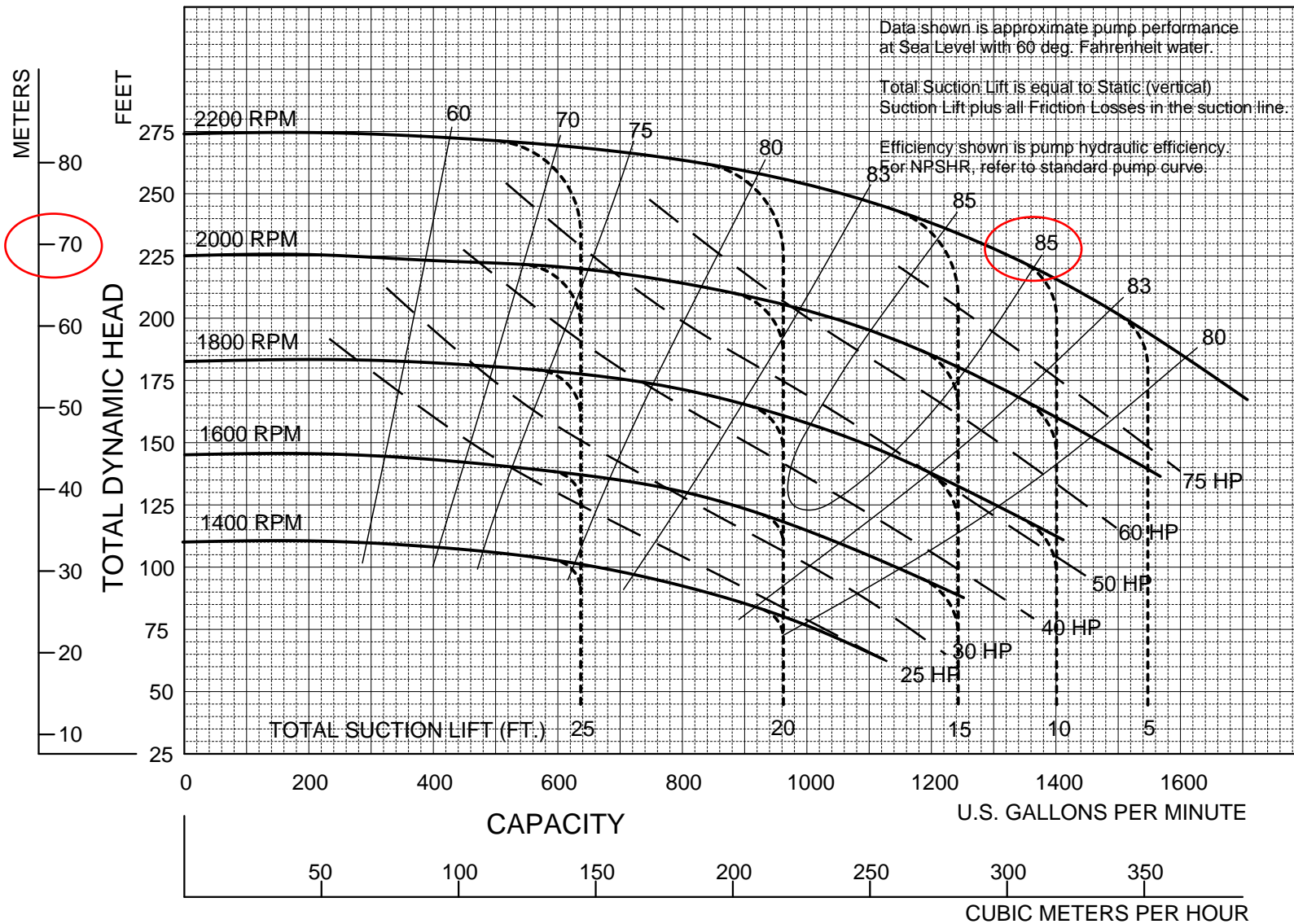

Data shown is approximate pump performance at Sea Level with 60 deg. Fahrenheit water.
 Total Suction Lift is equal to Static (vertical) Suction Lift plus all Friction Losses in the suction line.
 Efficiency shown is pump hydraulic efficiency. For NPSHR, refer to standard pump curve.

Performances shown are for cool water, frame mounted configuration with Cyclo Seal.® Other liquids, seal arrangements or mounting configurations may require performance adjustments.

Add 1.5 HP for belt driven diaphragm vacuum pump. Performance curve does not include discharge check valve losses.

NEW PAGE

4RB RPV

10/09/03



Cornell Pump Company • Portland, Oregon

4RB REDI·PRIME® - VARIOUS RPM

Feet x .305 = Meters
 Inches x 25.4 = Millimeters
 GPM x .227 = Cubic Meters/Hour
 GPM x 3.785 = Liters/Minute
 HP x .746 = KW

Speed	Impeller Dia.	Style	Solids Dia.	N _S	Suction	Discharge	No. vanes
VARIOUS	VARIOUS	ENCLOSED	1"	1654	8"	5"	6

DOUBLE VOLUTE

MOUNTING CONFIG.: CC, VM, F, VF, EM, VC

HQ	TRIM	RPM	HQ	TRIM	RPM	HQ	TRIM	RPM	HQ	TRIM	RPM	FULL DIAMETER 13.50"
A	13.50"	2400	C	13.50"	2000	D	13.50"	1800	E	13.50"	1600	
B	13.50"	2200		12.38"	2200	12.25"	2000	12.12"	1800	12.12"	1800	
	12.44"	2400	11.44"	2400	11.31"	2200	11.19"	2000	10.12"	10.12"	2200	

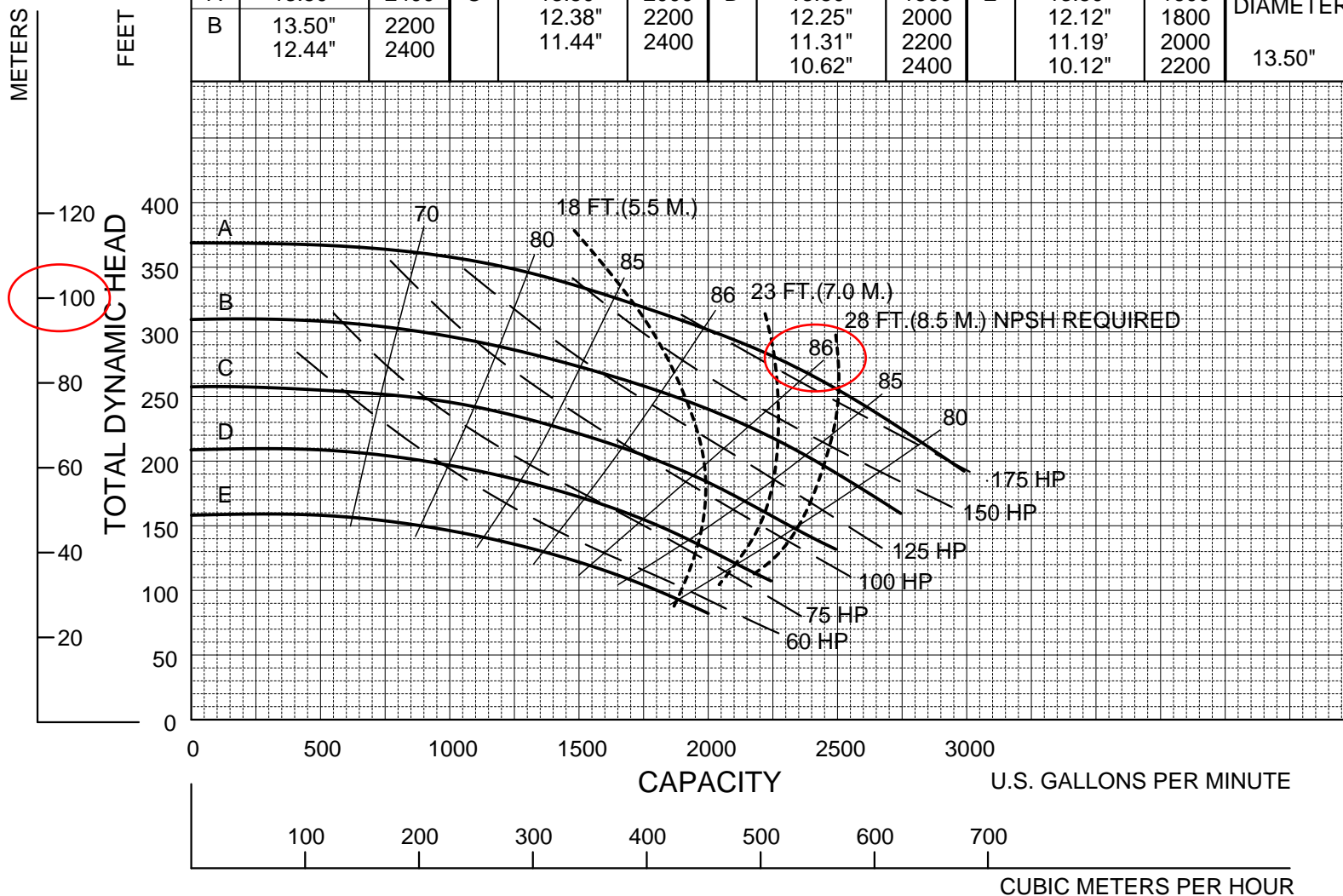

Performances shown are for cool water, close-coupled electric configuration with Cyclo Seal. Other mounting styles or liquids may require horsepower and/or performance adjustments.

NEW PAGE

5RBVA

9/6/00



Cornell Pump Company • Portland, Oregon

5RB - VARIOUS RPM

Feet x .305 = Meters
 Inches x 25.4 = Millimeters
 GPM x .227 = Cubic Meters/Hour
 GPM x 3.785 = Liters/Minute
 HP x .746 = KW

Speed	Impeller Dia.	Style	Solids Dia.	N _S	Suction	Discharge	No. vanes
VARIOUS	VARIOUS	ENCLOSED	1.31"	2209	10"	6"	6

DOUBLE VOLUTE

MOUNTING CONFIG.: CC, VM, F, VF, EM, VC

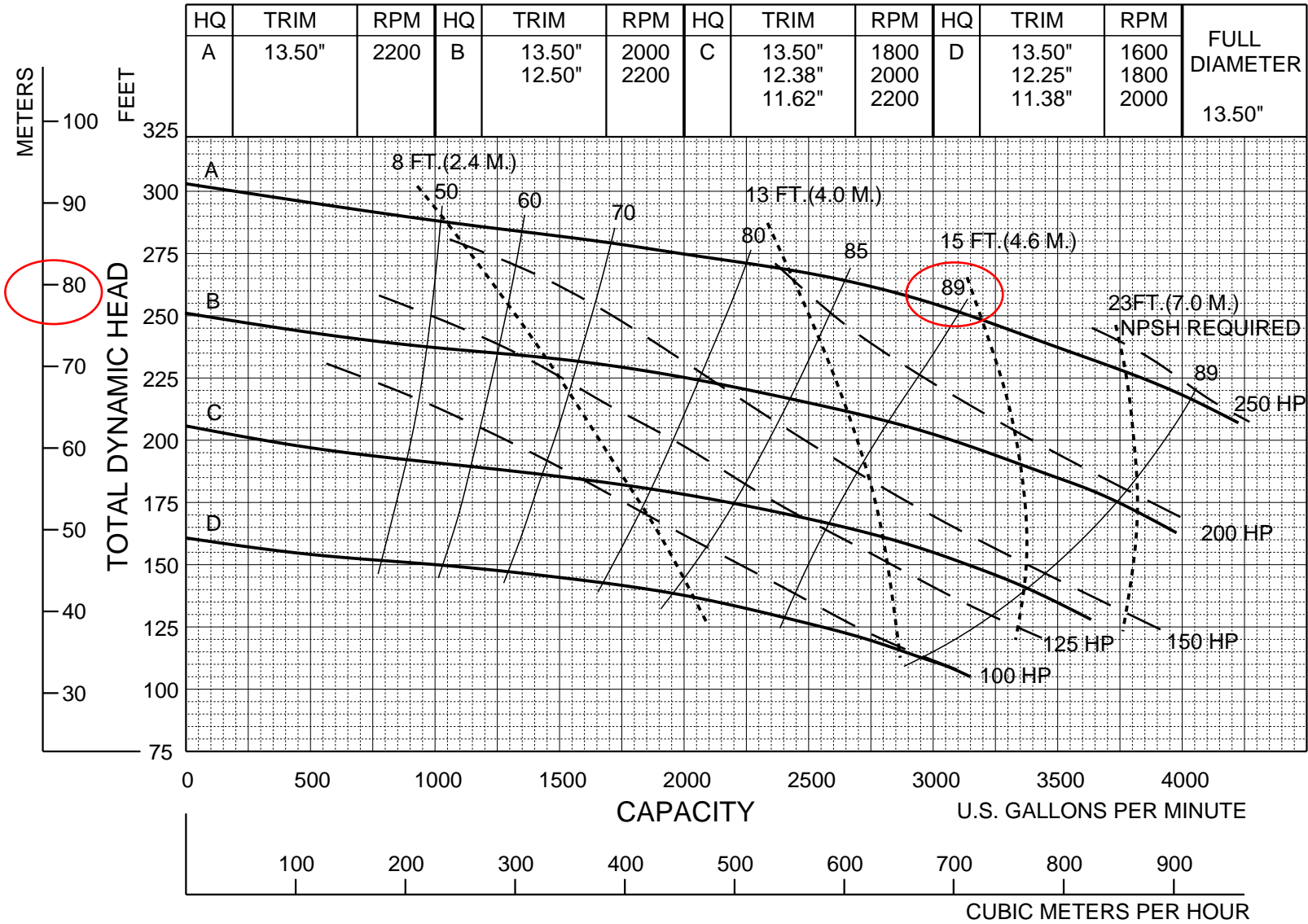

Performances shown are for cool water, close-coupled electric configuration with Cyclo Seal.™ Other mounting styles or liquids may require horsepower and/or performance adjustments.

NEW PAGE

6RBVA

9/99



Cornell Pump Company • Portland, Oregon

6RB - VARIOUS RPM

Feet x .305 = Meters
 Inches x 25.4 = Millimeters
 GPM x .227 = Cubic Meters/Hour
 GPM x 3.785 = Liters/Minute
 HP x .746 = KW

Speed	Impeller Dia.	Style	Solids Dia.	N _S	Suction	Discharge	No. vanes
VARIOUS	VARIOUS	ENCLOSED	1.25"	2081	10"	8"	6

DOUBLE VOLUTE

MOUNTING CONFIG.: CC, VM, F, VF, EM, VC

HQ	TRIM	RPM	HQ	TRIM	RPM	HQ	TRIM	RPM	HQ	TRIM	RPM	FULL DIAMETER 15.22"
A	15.22"	2000	C	15.22"	1800	D	15.22"	1700	E	15.22"	1600	
B	15.22"	1900		14.62"	1900		14.62"	1800		14.56"	1700	
	14.62"	2000		14.12"	2000		14.12"	1900		14.00"	1800	
							13.25"	2000		13.25"	1900	

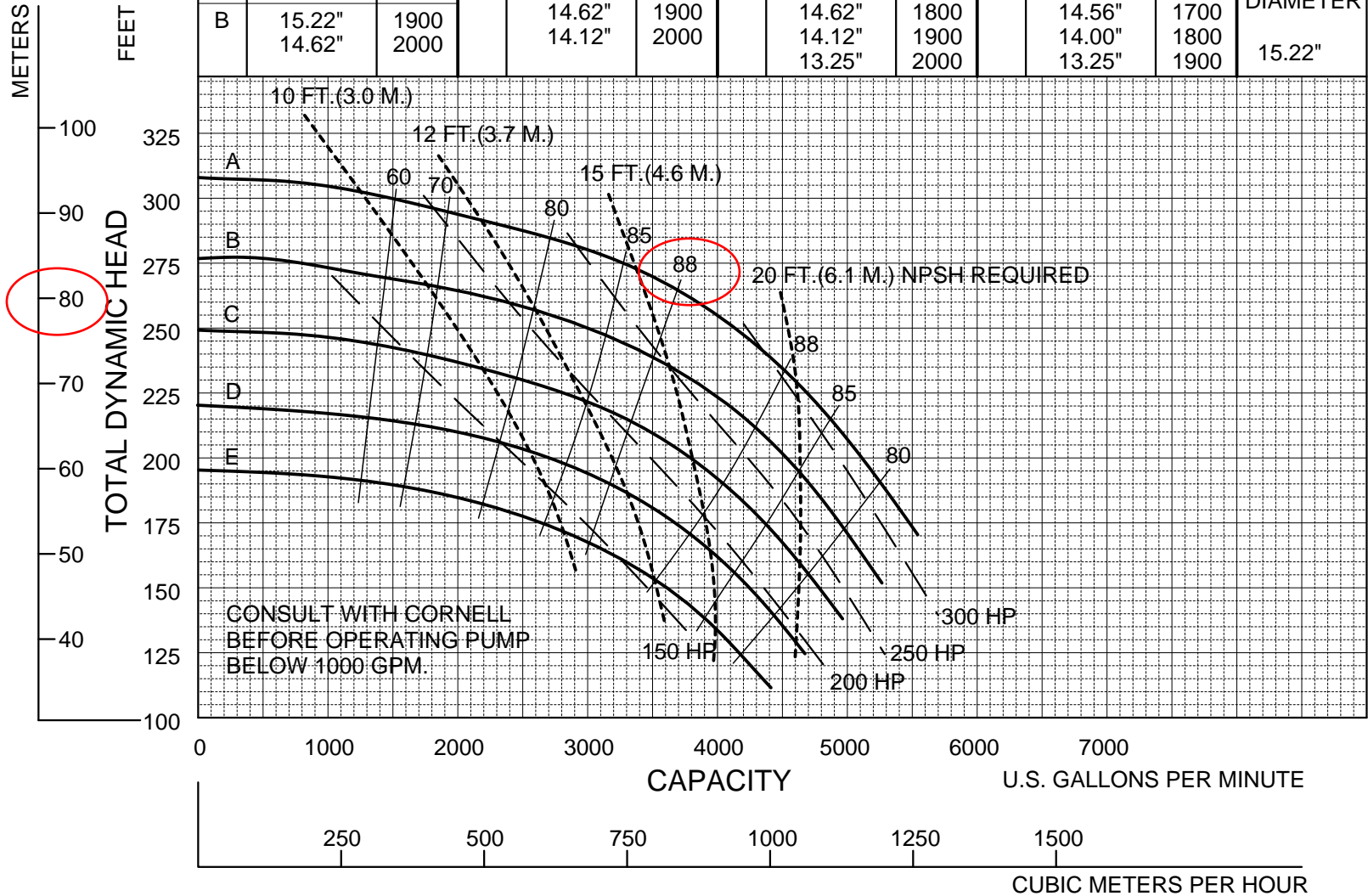

Performances shown are for cool water, close-coupled electric configuration with Cyclo Seal.™ Other mounting styles or liquids may require horsepower and/or performance adjustments.

CONSULT WITH CORNELL BEFORE OPERATING PUMP BELOW 1000 GPM.



Cornell Pump Company • Portland, Oregon

8H - VARIOUS RPM

Feet x .305 = Meters
 Inches x 25.4 = Millimeters
 GPM x .227 = Cubic Meters/Hour
 GPM x 3.785 = Liters/Minute
 HP x .746 = KW

Speed	Impeller Dia.	Style	Solids Dia.	N _S	Suction	Discharge	No. vanes
VARIOUS	12.0"	ENCLOSED	3"	1540	4"	4"	2

SINGLE VOLUTE

MOUNTING CONFIG.: CC, VM, F, VF, EM, VC

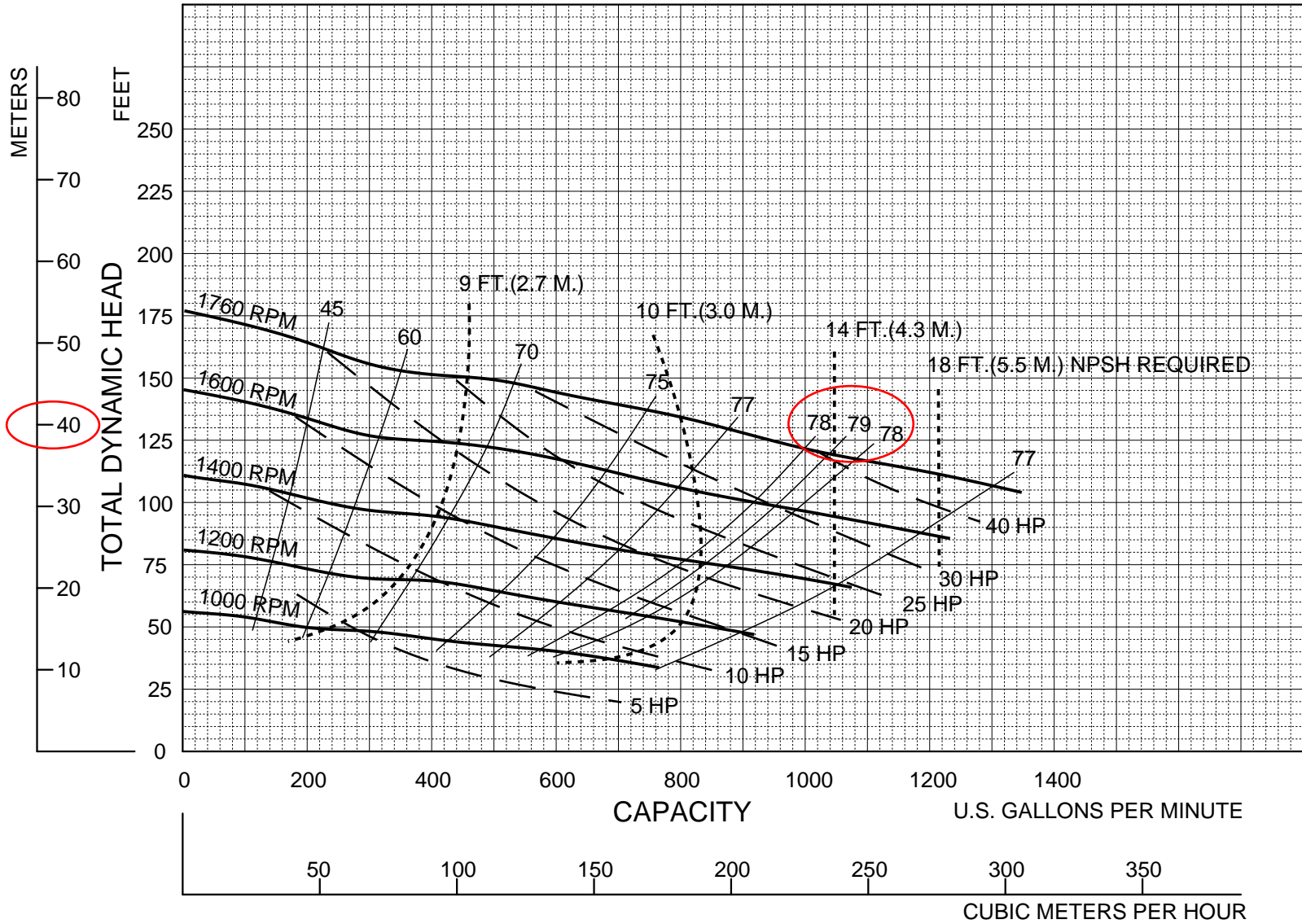

Performances shown are for cool water, close-coupled electric configuration with Cyclo Seal.™ Other mounting styles or liquids may require horsepower and/or performance adjustments.



Cornell Pump Company • Portland, Oregon

4NHTA - VARIOUS RPM

9/15/99

NEW PAGE

4NHTAVA

Feet x .305 = Meters
 Inches x 25.4 = Millimeters
 GPM x .227 = Cubic Meters/Hour
 GPM x 3.785 = Liters/Minute
 HP x .746 = KW

Speed	Impeller Dia.	Style	Solids Dia.	N _S	Suction	Discharge	No. vanes
VARIOUS	17.5"	ENCLOSED	3.0"	980	5"	4"	2

SINGLE VOLUTE

MOUNTING CONFIG.: CC, VM, F, VF, EM, VC

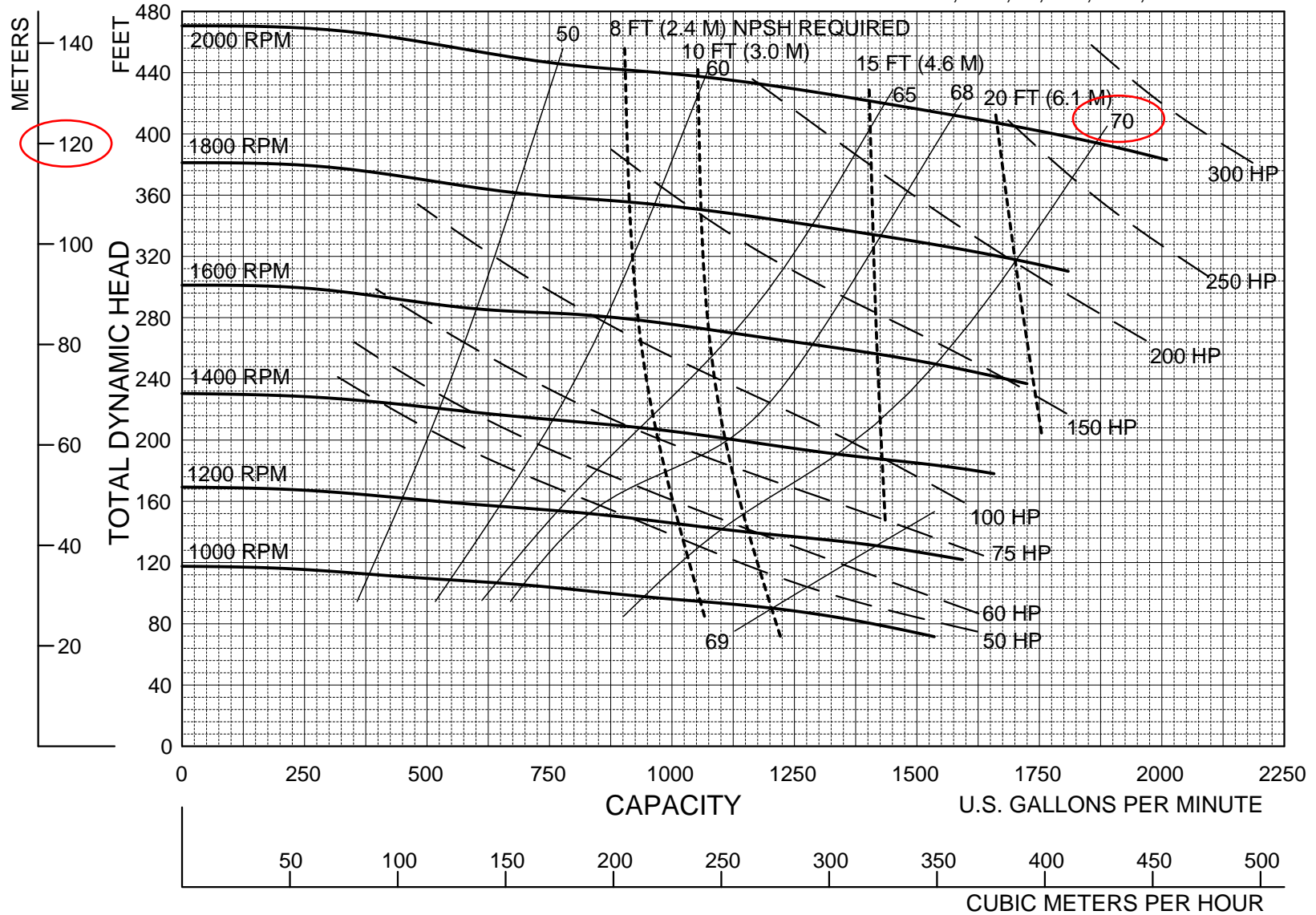

Performances shown are for cool water, horizontal frame configuration with Cyclo Seal®. Other liquids may require horsepower and/or performance adjustments.

07/17/2000



Cornell Pump Company • Portland, Oregon

4NHTB VARIOUS RPM

Feet x .305 = Meters
 Inches x 25.4 = Millimeters
 GPM x .227 = Cubic Meters/Hour
 GPM x 3.785 = Liters/Minute
 HP x .746 = KW

Speed	Impeller Dia.	Style	Solids Dia.	N _S	Suction	Discharge	No. vanes
VARIOUS	14.0"	ENCLOSED	3"	2120	6"	6"	2

SINGLE VOLUTE

MOUNTING CONFIG.: CC, VM, F, VF, EM, VC

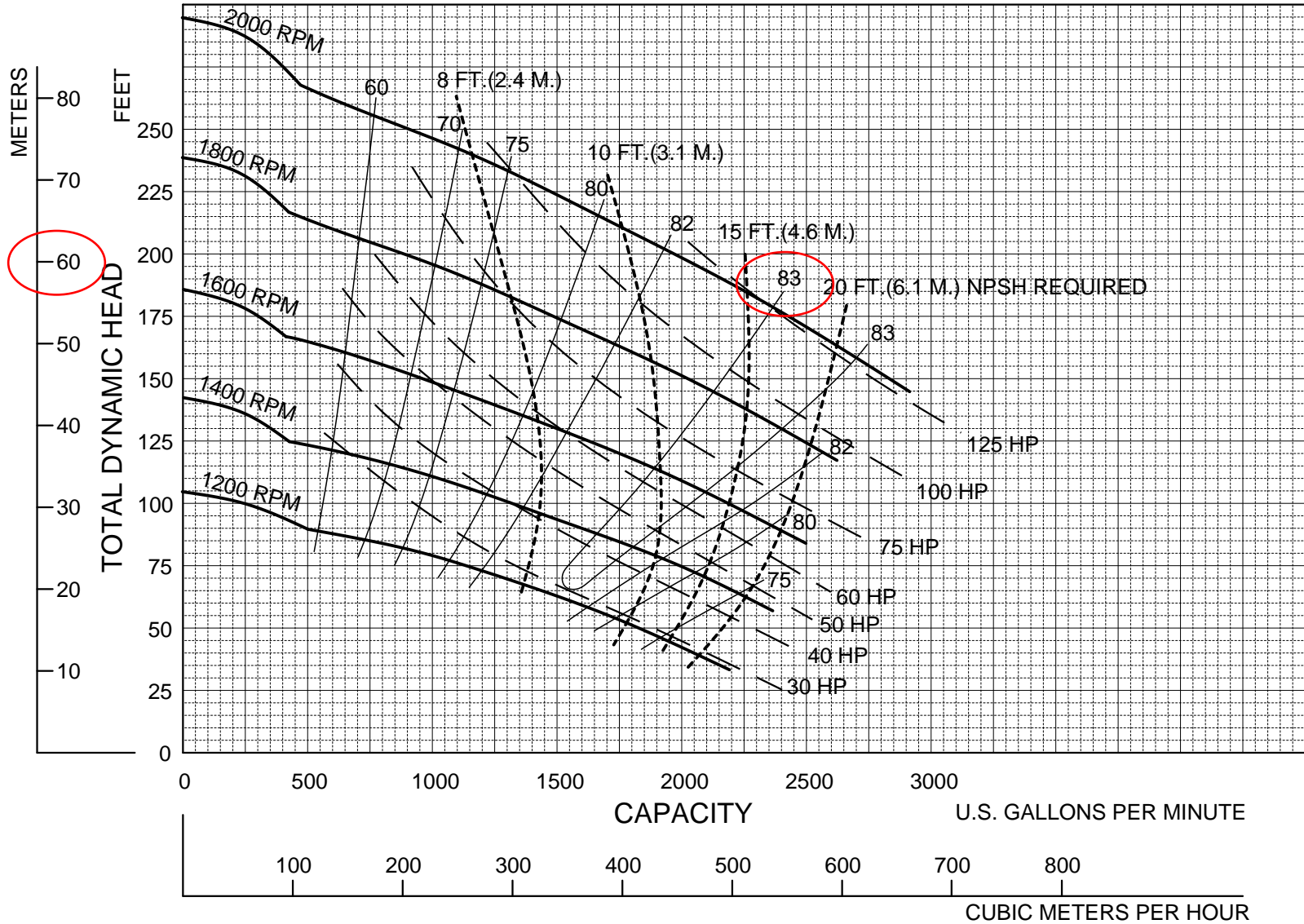

Performances shown are for cool water, close-coupled electric configuration with Cyclo Seal.® Other mounting styles or liquids may require horsepower and/or performance adjustments.

SUPERSEDED 11/02/00

6NHTAV/2

12/13/00



Cornell Pump Company • Portland, Oregon

6NHTA - VARIOUS RPM

Feet x .305 = Meters
 Inches x 25.4 = Millimeters
 GPM x .227 = Cubic Meters/Hour
 GPM x 3.785 = Liters/Minute
 HP x .746 = KW

Speed	Impeller Dia.	Style	Solids Dia.	N _S	Suction	Discharge	No. vanes
1780	VARIOUS	ENCLOSED	4.75"	2700	12"	10"	2

DOUBLE VOLUTE

MOUNTING CONFIG.: CC, VM, F, VF, EM, VC,

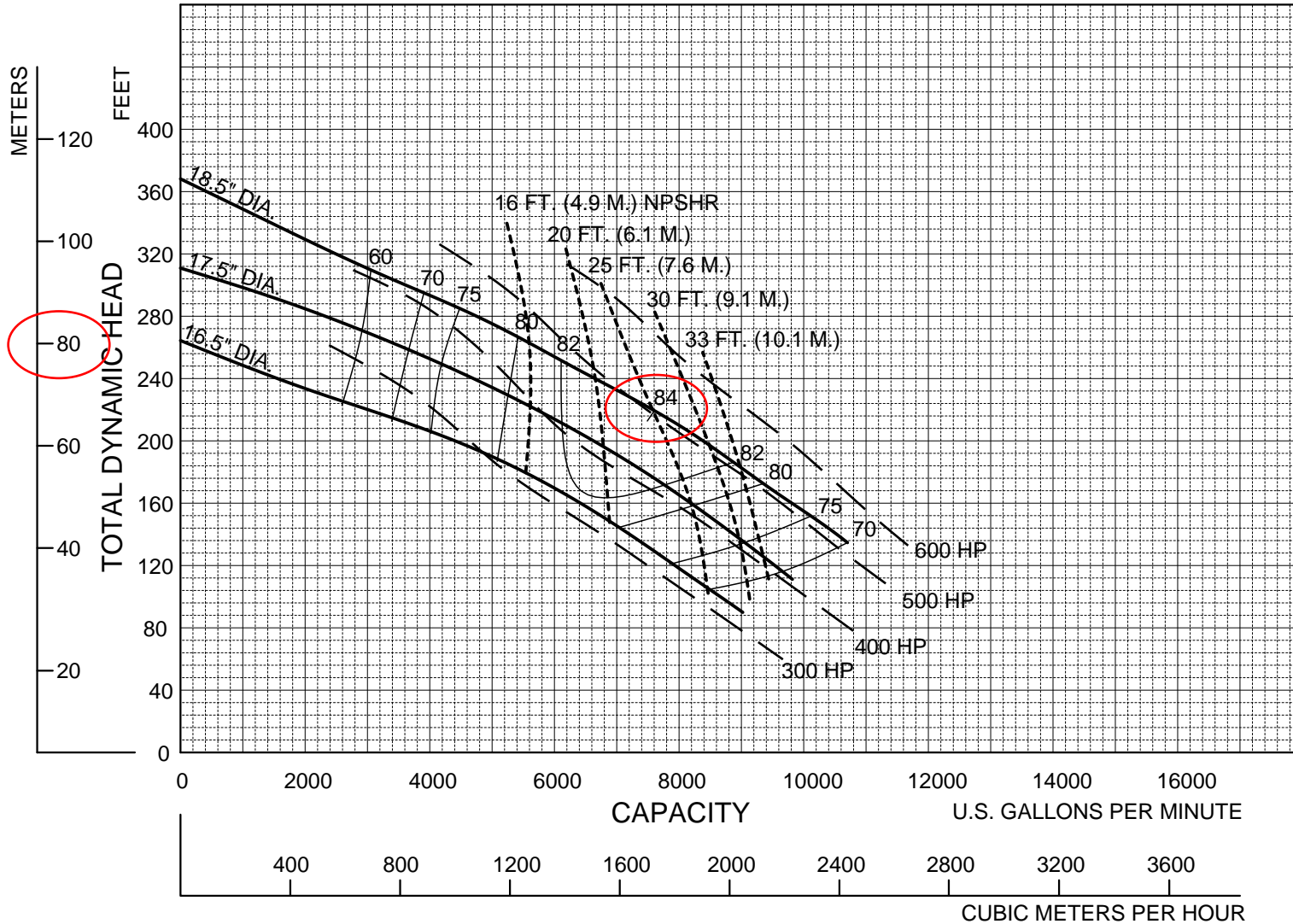

Performances shown are for cool water, close-coupled electric configuration with packing. Other mounting styles or liquids may require horsepower and/or performance adjustments.

NEW PAGE

10NHTB18

09/16/03



Cornell Pump Company • Portland, Oregon

10NHTB - 1800 RPM

Efficient by Design

Feet x .305 = Meters
 Inches x 25.4 = Millimeters
 GPM x .227 = Cubic Meters/Hour
 GPM x 3.785 = Liters/Minute
 HP x .746 = KW

Speed	Impeller Dia.	Style	Solids Dia.	N _S	Suction	Discharge	No. vanes
VARIOUS	28"	ENCLOSED	4.25"	1800	14"	14"	3

DOUBLE VOLUTE

MOUNTING CONFIG.: F, VF, EM, VC

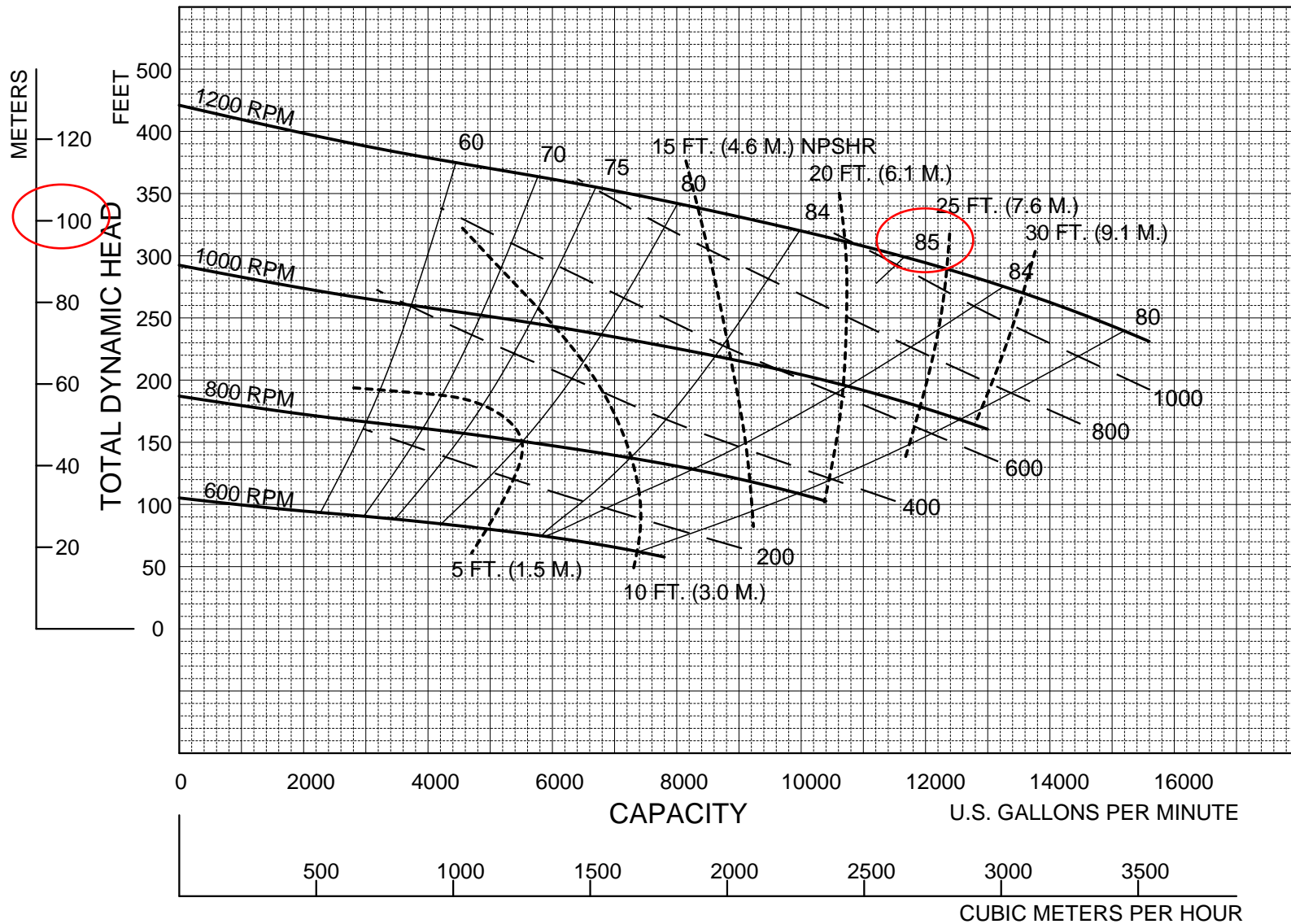

Performances shown are for cool water, horizontal frame configuration with Cycloseaal®. Other liquids may require horsepower and/or performance adjustments.



Cornell Pump Company • Portland, Oregon

14NHG28 - VARIOUS RPM

4/20/00

NEW PAGE

14NHG28VA

Feet x .305 = Meters
 Inches x 25.4 = Millimeters
 GPM x .227 = Cubic Meters/Hour
 GPM x 3.785 = Liters/Minute
 HP x .746 = KW

Speed	Impeller Dia.	Style	Solids Dia.	N _S	Suction	Discharge	No. vanes
985 RPM	VARIOUS	ENCLOSED	5.0"	2890	20"	18"	4

SINGLE VOLUTE

MOUNTING CONFIG.: F, VF, VC

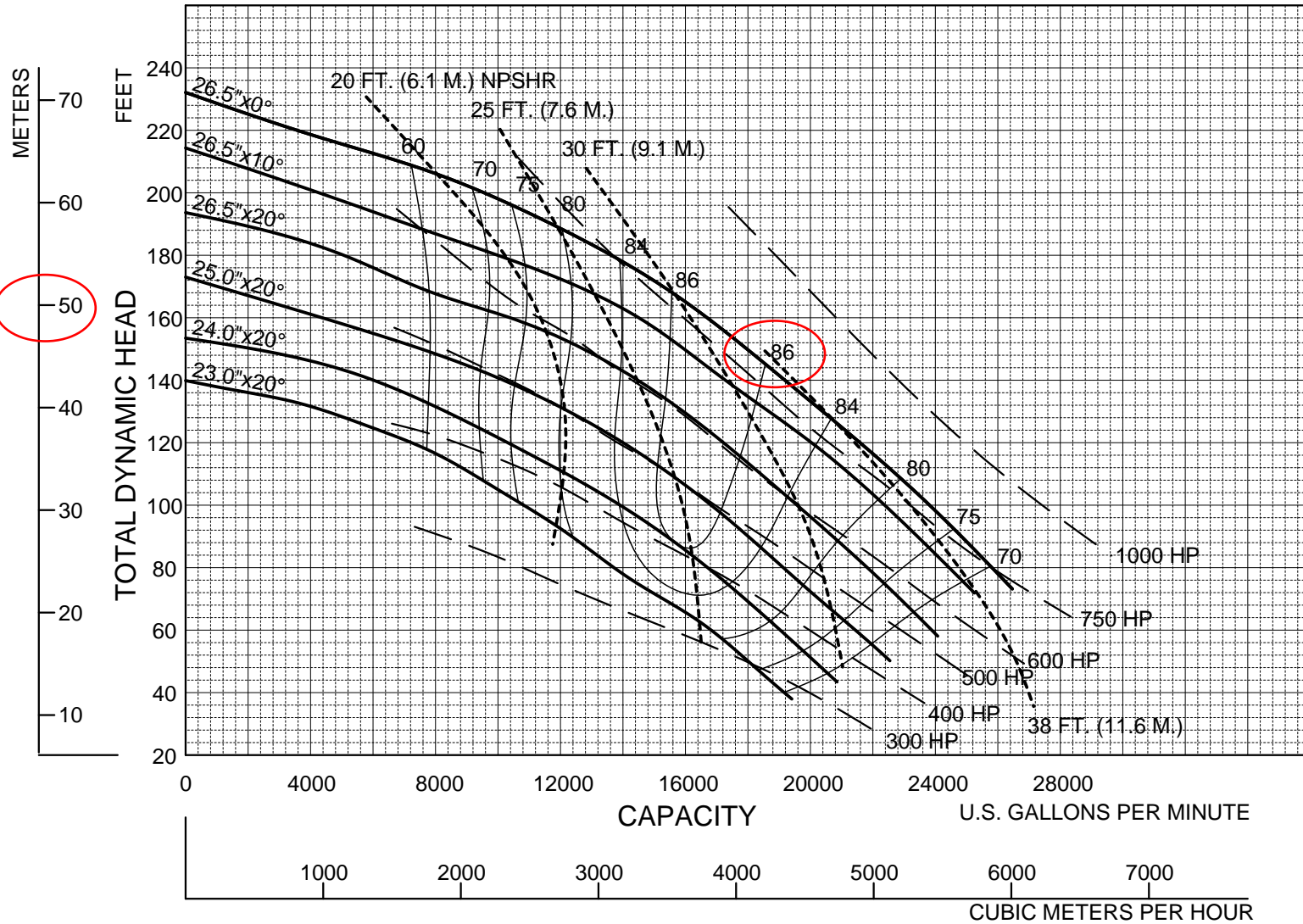

Performances shown are for cool water, frame mounted configuration with packing. Other liquids, mounting configurations, or seal arrangements may require horsepower and/or performance adjustments.



Cornell Pump Company • Portland, Oregon

18NHFL - 1000 RPM

01/26/04

NEW PAGE

18NHFL10

Feet x .305 = Meters
 Inches x 25.4 = Millimeters
 GPM x .227 = Cubic Meters/Hour
 GPM x 3.785 = Liters/Minute
 HP x .746 = KW

Speed	Impeller Dia.	Style	Solids Dia.	N _S	Suction	Discharge	No. vanes
505	VARIOUS	ENCLOSED	8.5"	2440	42"	42"	4

SINGLE VOLUTE

MOUNTING CONFIG.: F, VF, VC

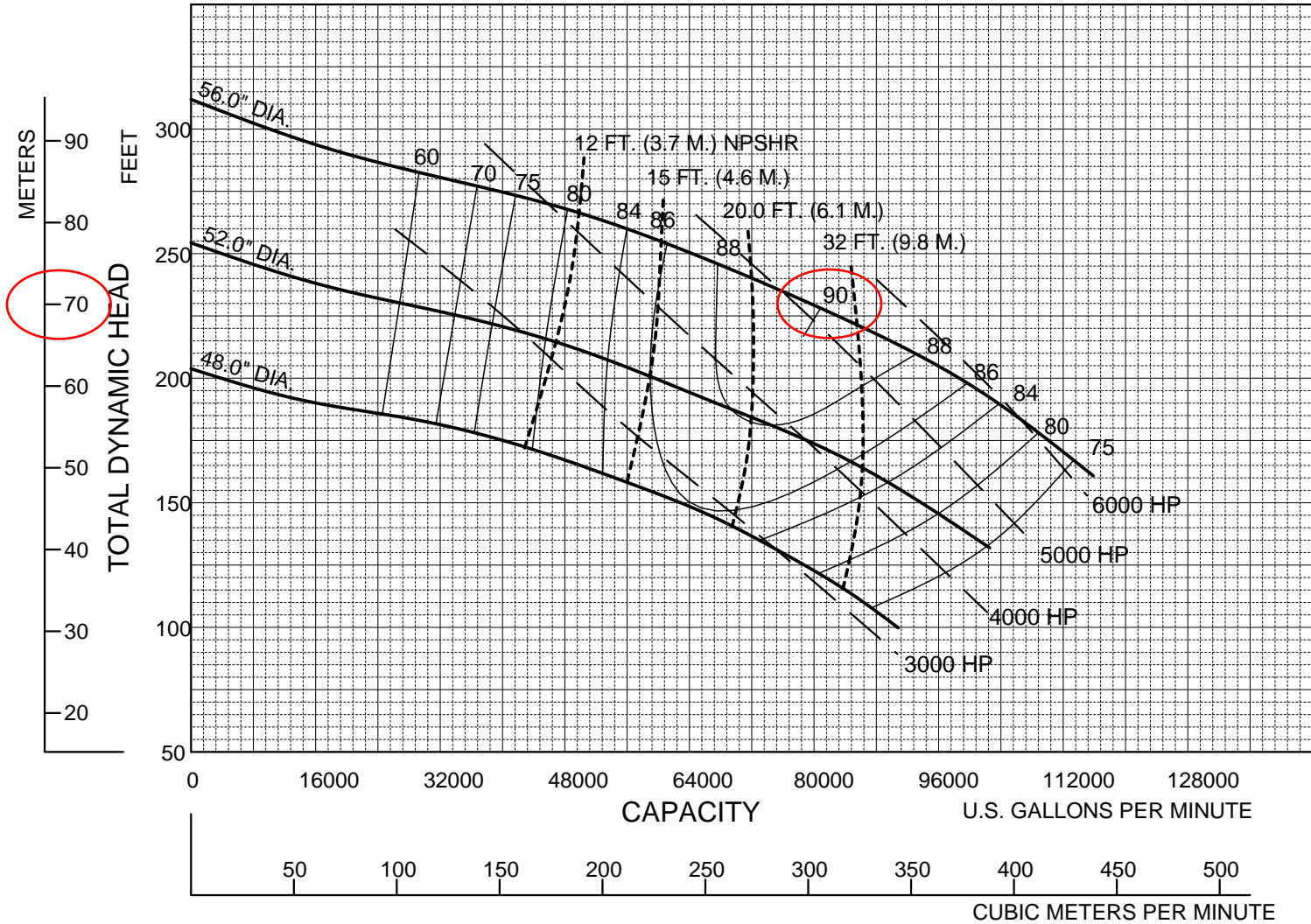

Performances shown are for cool water, close-coupled electric configuration with Cyclo Seal®. Other mounting styles or liquids may require horsepower and/or performance adjustments.



Cornell Pump Company • Portland, Oregon

42NHF - 515 RPM

8/14/02

NEW PAGE

42NHF515



Introducing MX Series... Mining Pumps with the Best Performance in the Industry



***Cornell's New MX Series High Head Mining Pumps
Beat the Competition Hands Down
in Efficiency and Performance!***

- ✓ ***DISCHARGE SIZES 3", 4" &
6" AVAILABLE***
- ✓ ***600 - 750 FT TDH
Flows to 3800 GPM***
- ✓ ***CA6NM IMPELLERS***
- ✓ ***DUCTILE IRON CASE***
- ✓ ***CORNELL PUMP QUALITY***
- ✓ ***INDUSTRY LEADING
EFFICIENCY***
- ✓ ***2 YEAR WARRANTY***



A NEW LINE ...

of High Head Mining Pumps



APPLICATION

Cornell has incorporated many unique and innovative design features into its mining pumps, while maintaining its position in the industry as the leader of heavy-duty, low maintenance units. Cornell's mining pumps have been used successfully in a variety of mining and dewatering applications. These new pumps are designed specifically to handle high head applications while providing a long service life.



ENCLOSED IMPELLERS



The new high head pumps have four vane enclosed impellers designed to handle solids up to 2" and have excellent efficiencies - up to 75%.

MOUNTING STYLES AVAILABLE

- Horizontal Frame Mount
- SAE Engine Mount



PRODUCT DIVERSITY

Many Cornell innovations have evolved from our commitment to the mining market and our ongoing effort to work with the industry in providing solutions for mining and dewatering applications.

- High Operating Pressures
- High Flow Requirements
- High Efficiency
- Dependable, High Quality Construction - CA6NM Impeller is Standard



250lb rated flanges

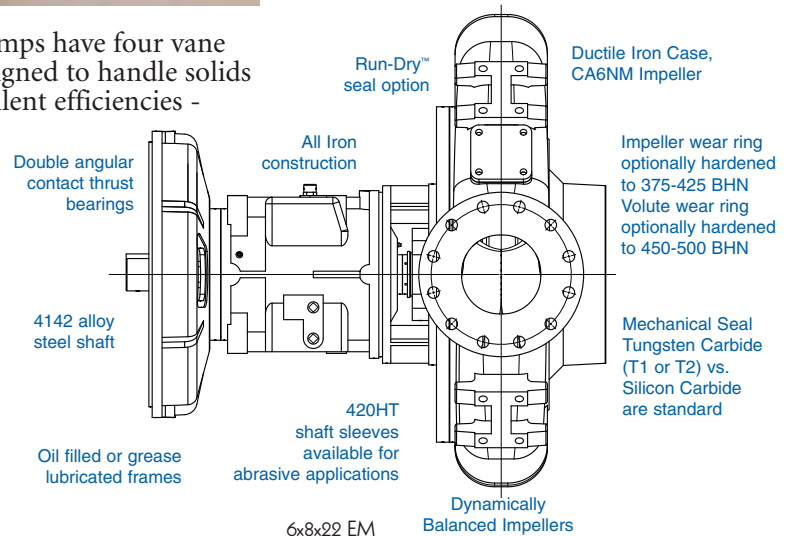

6822MX

Speed	Impeller Dia.	Style	Solids Dia.	N _S	Suction	Discharge	No. vanes
VARIOUS	21.95"	ENCLOSED	2.00"	709	8"	6"	4

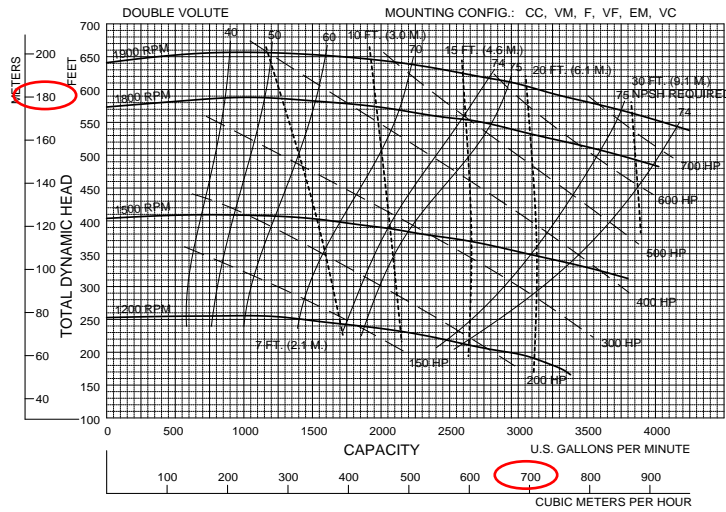

Performances shown are for cold water, close to complete electric configuration with Cyclo Seal. Other mounting configurations, seal arrangements or fluids may require horsepower and/or performance adjustments.

CYCLOSEAL®

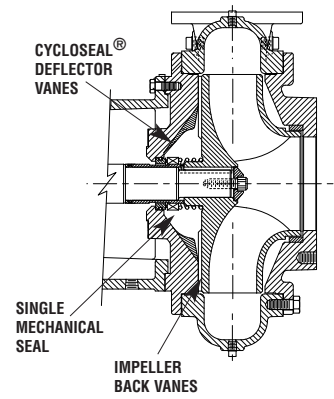

RUN-DRY™ OPTION

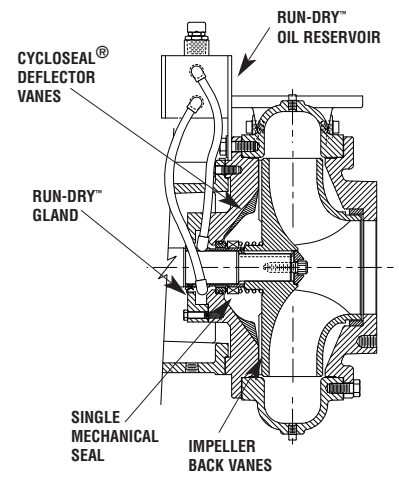

4622MX

Speed	Impeller Dia.	Style	Solids Dia.	N _S	Suction	Discharge	No. vanes
VARIOUS	21.95"	ENCLOSED	.98"	552	6"	4"	4

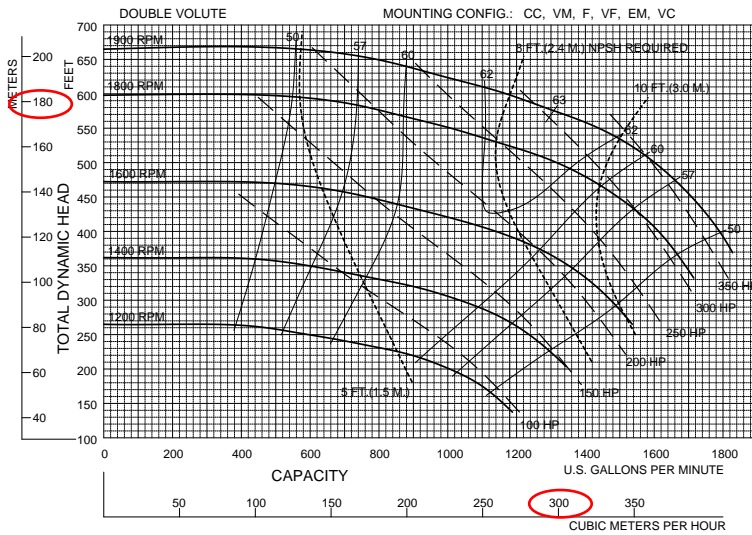

Performances shown are for cold water, close to complete electric configuration with Cyclo Seal. Other mounting configurations, seal arrangements or fluids may require horsepower and/or performance adjustments.

REDI-PRIME® SYSTEM

- Vacuum Assist (Diaphragm) Pump
- Patented Cyclo Seal® & Run-Dry™ features
- Fully automatic, compact, self-priming
- High Hydraulic Efficiencies

Operation of Cornell's Redi-Prime® System

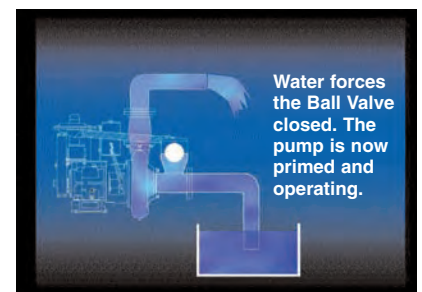
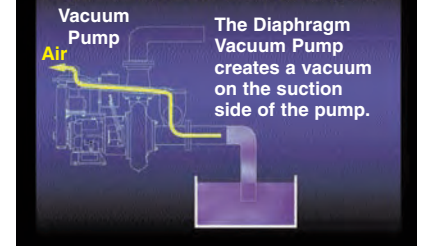

3419MX

Speed	Impeller Dia.	Style	Solids Dia.	N _S	Suction	Discharge	No. vanes
VARIOUS	19.59"	ENCLOSED	.70"	450	4"	3"	5

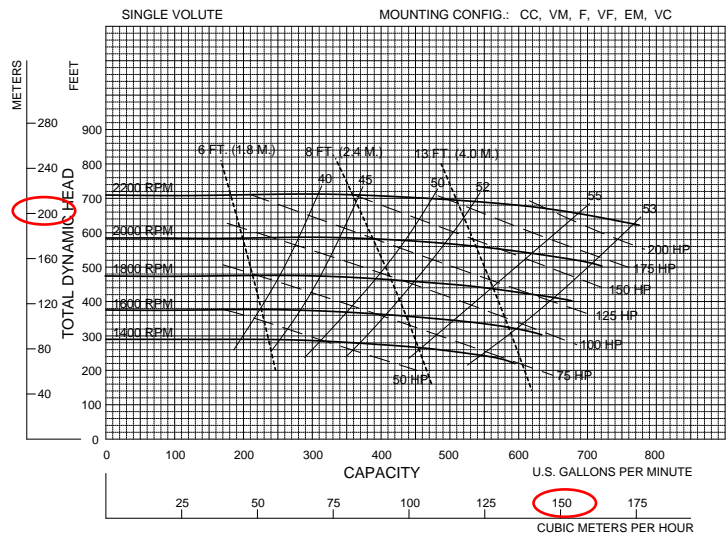

Performances shown are for cold water, close to complete electric configuration with Cyclo Seal. Other mounting configurations, seal arrangements or fluids may require horsepower and/or performance adjustments.

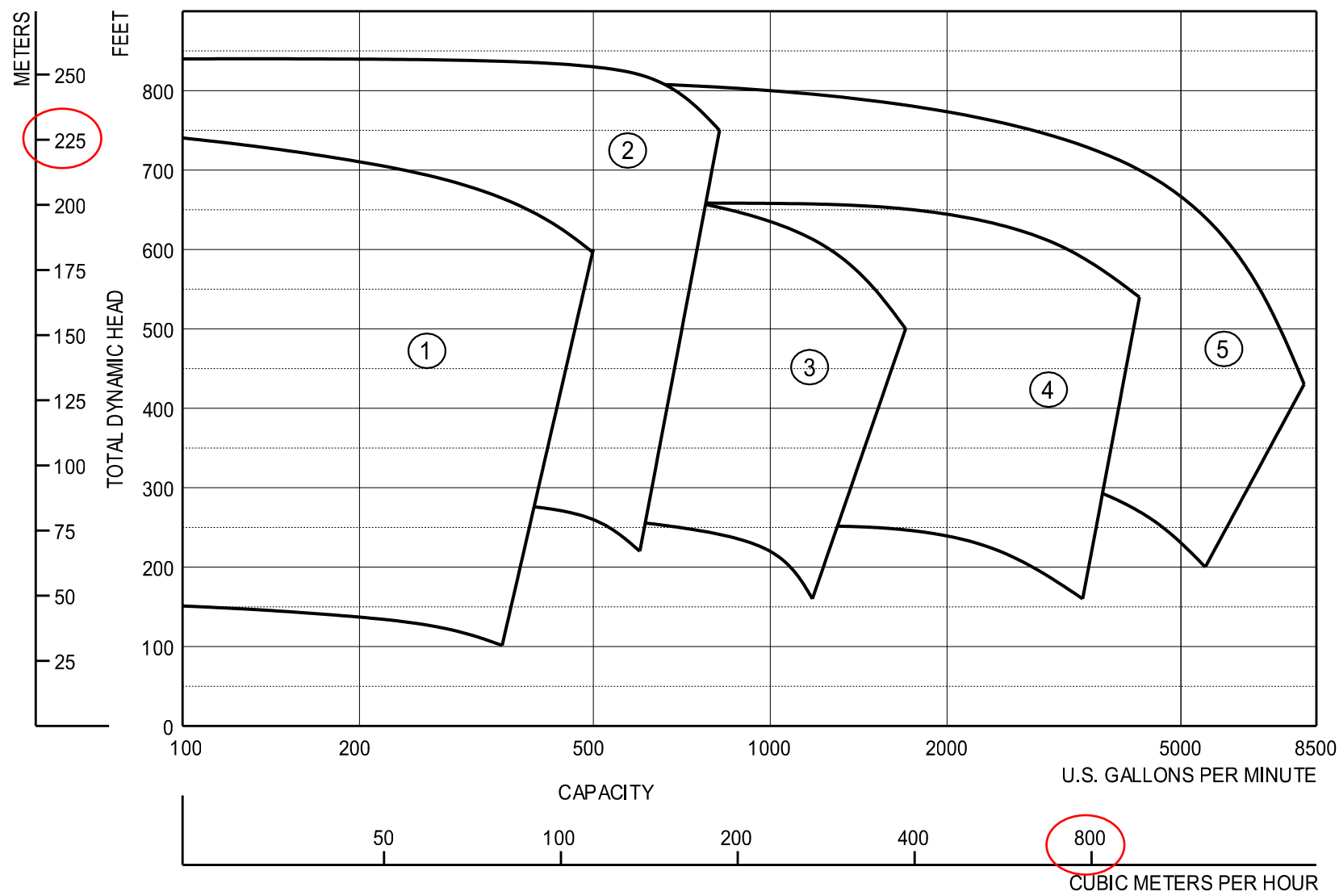

- MODEL
- 1. 2415MX
 - 2. 3419MX
 - 3. 4622MX
 - 4. 6822MX
 - 5. 81026MX

3/30/12



Cornell Pump Company • Portland, Oregon

MX SERIES - VARIOUS RPM